

The integrator PolluTherm is used for energy consumption measurement in heating or cooling systems filled with the energy carrier liquid water. PolluTherm may also be used with water containing antifreeze using a programmed correction factor. In this case the PolluTherm is not officially metrologically calibrated. These installation and operation instructions specify how to install and operate the integrator PolluTherm. They are an essential part of the supplied items and shall be handed over to the final user.

Content

Supplied items	1
1. Technical data	1
2. Safety instructions	2
3. Required tools.....	2
4. Combination of the sub-units.....	2
4.1 Programming the input pulse value	3
5. Installation of the sub-units.....	3
5.1 Flow sensor.....	4
5.3 Mounting of the integrator	5
6. Connection of the sub-units.....	5
6.1 Connection of the flow sensor.....	5
6.2 Connection of the temperature sensors.....	5
7. Exchange of the integrator module.....	6
8. Display options	6
8.1 User menu (example)	7
8.2 Target day menu (example).....	7
8.3 Archive menu (example).....	8
8.4. Service menu (example).....	8
8.5 Control menu for tariff purposes (example).....	9
8.6 Parameter menu (example)	9
9. Functional test, sealing	10
10. Potential error situations.....	10
11. Data interface and options.....	11
11.1 Optical interface	11
11.2 Mini-Bus interface	11
11.3 M-Bus-plug-in unit acc. to EN 13757-3.....	11
11.4 Remote reading plug-in unit.....	11
11.5 M-Bus plug-in unit with two contact inputs	11
11.6 USB plug-in unit (for M-Bus slot)	12
11.7 USB plug-in unit with 2 inputs for external consumption meters (for M-Bus slot).....	12
11.8 LONWORKS®-FTT10A (for M-Bus slot) .	12
11.9. Inserting the plug-in unit into the heat meter	12
11.10 Combined heating/cooling meter (ordering option).....	12
11.11 Optional integrated data logger (ordering option)	12
11.12 Retrofitting from battery unit to power supply unit.....	13
12. Information on the extension of temperature sensor cables.....	13
Annex 1: Declaration of conformity acc. directive 2004/22EC (MID).....	14

Supplied items

- Integrator PolluTherm (incl. temperature sensors and immersion sleeves, where appropriate)

Sealing material (self-lock seals, sealing wire), cable binders for strain relief

- Fastening material (2 screws, 2 dowels, C-rail)

- These installation and operating instructions

1. Technical data

Integrator	
Temperature measuring range	$\Theta = 1 \dots 180 \text{ }^\circ\text{C}$
Temperature difference range	$\Delta\Theta = 3 \dots 150 \text{ K}$
Switch-off threshold	0,15 K
Measuring accuracy	Better than (%): $+ (0,5 + \Delta\Theta_{\min} / \Delta\Theta)$
Updating time and integration cycles resp.:	
- Temperatures	2 sec
- Flow rate, power	4 sec
- Energy, volume	4 sec (16 sec *)
	* in case of battery supply
Optical data interface	Physical acc. to EN 61107 Data record acc. to EN 13757-3
Suitable temperature sensors	Pt 500 Connection in two- or four-wire technology
Power supply (certification period of the meter may be defined by national laws)	Battery for 6 years (optional: 11 years) or mains supply 230 V AC or 24 V AC
Electromagnetic environment condition	Class E 1
Mechanical environment condition	Class M 2
Protection class	IP 54
Ambient temperature	5 ... 55 °C
Storing temperature	-20 ... +65 °C
Relative air humidity	< 93 %
Size (H x B x T) in terms of wall mounting	ca. 159 x 125 x 52 mm

Pulse input value in l	0,25 or 1	2,5 or 10	25 or 100	250, 1.000 or 10.000
Display of the integrator with decimal digits for m³, MWh or GJ	00000,000	000000,00	0000000,0	00000000
Pulse value in case of remote heat quantity reading in MWh or GJ	0,001	0,01	0,1	1
Pulse value in case of remote volume reading in l	1	10	100	1.000

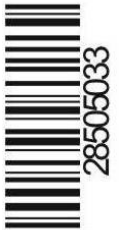

2. Safety instructions



- The installation of PolluTherm requires adequate professional knowledge and should be carried out by specially trained persons only.
- Due to the danger of scalding from leaking heating liquid ensure proper installation when mounting PolluTherm, immersion sleeves or ball valves. Therefore close the shut-off valves before disassembly.
- Depending on manufacturing conditions the brass connection threads might be sharp-edged. Therefore we recommend wearing protection gloves.
- Heating or cooling meters are measuring instruments and have to be handled with care. In order to protect them against damage and dirt they should only be taken from the package immediately before installation.
- If the housing or the contact cables are damaged the device shall be taken out of service and secured against accidental reconnection.
- Clean only with a cloth dampened in water.
- Depending on the version the device has a battery. This battery may not be opened by force, put in contact with water, short-circuited or exposed to temperatures of more than 80 °C
- Empty batteries, electronic devices or components that are not needed anymore are special waste and have to be disposed at appropriate collection points.
- To ensure fair consumption billing, when using several meters in one billing unit, similar meter types and installation positions should be used.

Mains-operated devices:

The power modules (230 V AC or 24 V AC) must be fed from supplies fused at 6 A protection. **Only specially trained and authorized personnel are permitted to carry out the connection.** Moreover attention is to be paid to the national technical rules.

Voltage: 220 ... 240 V AC
or 24 V AC
Frequency: 50/60 Hz
Max. power consumption: 0,5 VA
Cable length: ca. 1,1 m

3. Required tools

- Appropriate spanner wrench or screw wrench for screw connection and flange screws respectively.
- Slot screw driver 0,5 x 3 for clamp terminal block
- Allen key size 3 for wall adapter
- Side cutter for sealing wire
- Fork wrench SW 24 (immersion sleeves)

4. Combination of the sub-units

Each measuring point is composed of:

- Flow sensor
- Integrator PolluTherm
- One pair of temperature sensors, if necessary. with two immersion sleeves or ball valves

For assistance to find the correct standard combination, the sub-units are marked with graphical symbols according to the table below:

Flow sensor:

Size	Output pulse value	Symbol
QN 1,5 to 10	10 litres	△
QN 15 to 100	100 litres	○
QN 150 to 600	1.000 litres	⊗

Integrator PolluTherm*:

Input pulse value	Symbol
10 litres	△
100 litres	○
1.000 litres	⊗

* The version with programmable input pulse value is without any symbol

Temperature sensors:

Length	Symbol
47 or 100 mm	△□
150 mm	⊗

Take care to assemble only sub-units marked with the same symbol.

Combination example for the symbol „triangle“:

- Flow sensor QN / Qp 10
- PolluTherm with input pulse value of 10 litres
- Temperature sensors overall length 47 or 100 mm

4.1 Programming the input pulse value

This paragraph is only applicable for instruments where no input pulse value has been pre-programmed in the factory.

Attention!

Because of legal calibration regulations the input pulse value can only be programmed once. Therefore be sure that you have set the desired value before removing the bridge. Mains operated devices: make sure that the power supply is connected before programming the input pulse value.

This variant can be programmed only once with one of the following input pulse values (each one in litres):

0,25	1	2,5	10	25
100	250	1.000	10.000	

For this purpose activate the display by pressing the red key and releasing it again. Each of the above mentioned programmable input pulse values can be selected one after the other by a short keystroke. Having set the required value, remove the bridge between terminal 1 and 2 in the terminal block.

5. Installation of the sub-units

PolluTherm can not only be used as a heat meter but also as a cooling meter (optional: PolluTherm H, PolluTherm X H, s. a. chapter 11.10). Therefore the text hereinafter includes following terms:

Return pipe of heating systems: **Colder line**
Supply pipe of heating systems: **Warmer line**

Return pipe of cooling systems: **Warmer line**
Supply pipe of cooling systems: **Colder line**

Examples of installation in heating systems:

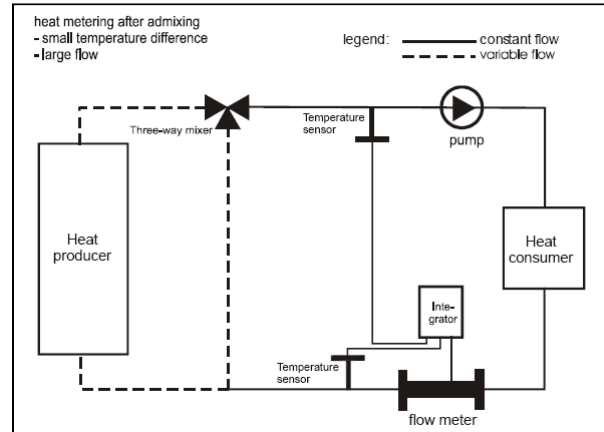

Figure 1: Measurement after admixing

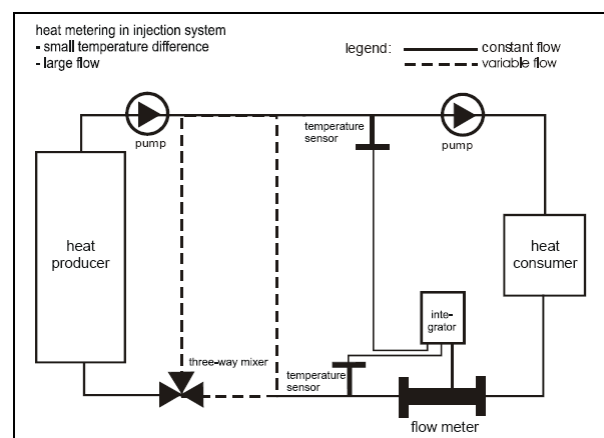

Figure 2: Measurement in injection system

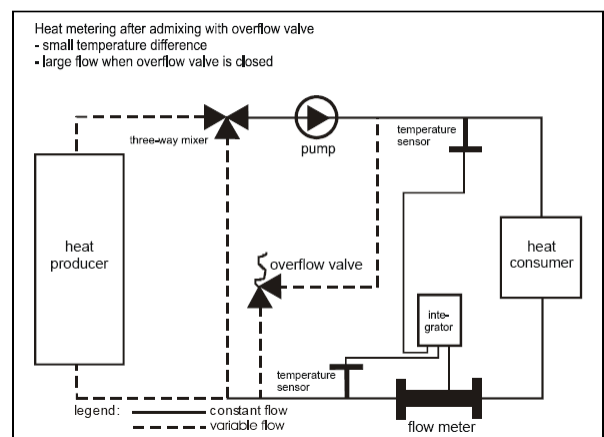

Figure 3: Measurement with overflow valve

5.1 Flow sensor

Applicable standards: EN 1434-6

Standard installation of the flow sensor is in the heating return pipe i.e. the colder line. If the flow sensor has to be installed in the heating supply pipe / the warmer line, PolluTherm X has to be used (X means that the integrator has been adjusted for flow sensors in the warmer line).

Installation in cooling systems:

It is recommended to install the flow sensor in the warmer line (return pipe) of the cooling device. PolluTherm X (installation in warmer line) has to be used. Please note the approved minimum temperature when using Sensus flow sensors:

AN 130 type (DN20 – DN40): $\geq 5\text{ }^{\circ}\text{C}$
 Woltman type WPD (\geq DN50): $\geq 10\text{ }^{\circ}\text{C}$
 Woltman type WSD (\geq DN 50) $\geq 15\text{ }^{\circ}\text{C}$

An arrow on the body shows the flow direction. The maximum operating pressure and the maximum operating temperature must not be exceeded. When using flow sensors starting from nominal size DN 50 (Woltman meters). A straight inlet pipe (area of steady flow) has to be provided as follows:

Type	Area of steady flow
WP and WS	Standard: 3 x DN
WP and WS	After manifolds, rotary pumps, throttling equipment: Flow straightener and 3 x DN
WS	After manifold: 5 x DN or flow straightener

After the flow sensor abrupt reductions of the pipe cross section are not allowed.

It is advisable to install a filter in front of the flow sensor or at another suitable point of the heating or cooling circuit as well as shut-off valves before and after the flow sensor (so that the pipe line doesn't have to be emptied when the meter has to be exchanged). Install a fitting piece during the initial installation instead of the flow sensor and flush the pipe system thoroughly. Then close the shut-off valves, remove the fitting piece, clean the sealing surfaces and install the flow sensor using new gaskets. Take care to not reduce the pipe diameter by bad positioning of the gaskets, particularly if flanged versions are installed.

5.2 Installation of the temperature sensors

PolluTherm operates with separately approved and paired temperature sensors type Pt 500. The

applicable type is specified on the front of the integrator.

We recommend the use of the MID starter kit consisting of special ball valves with temperature sensor entries M 10 x 1 with integrated union nuts and one spool piece (see manual MH 1131 INT). This starter kit is compatible with temperature sensor types L = 45 mm / D = 5,2 and DS 27,5. It is available up to R1 1/2" (DN 40).

When using Sensus temperature sensors, length 100 and 150mm the sensitive zone is ca. 10 to 15 mm measured from the temperature sensor's tip and has to be positioned as close as possible to the **middle of the pipe diameter**. Refer to the following guide for installing such temperature sensors:

Nominal sizes \leq DN 50*: Install the temperature sensors in an angle of 45° **towards** the flow direction (see figure 4).

Nominal sizes \geq DN 100*: Install the temperature sensors vertically to the flow direction (see figure 5).

For DN 65 and DN 80 both installation positions are valid

For larger nominal sizes (e.g. DN 150) the immersion sleeve has to be immersed at least as deep as 50 mm into the pipe.

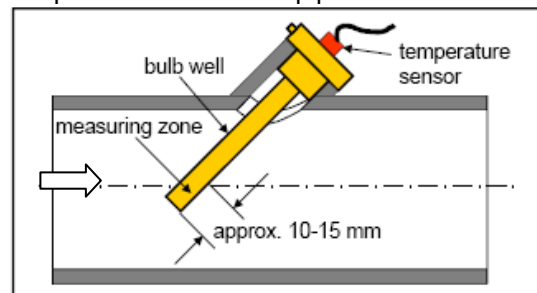

Fig. 4: Example diagram for nominal size DN 50
 * \leq DN 50 installation in a pipe elbow is also possible

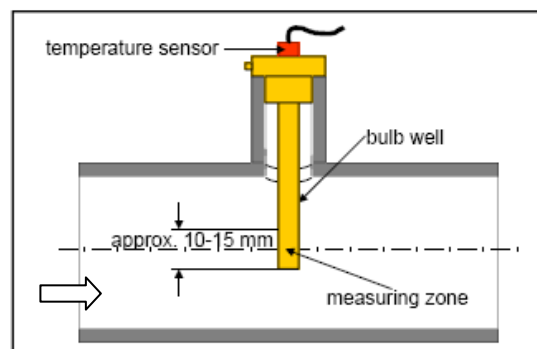

Fig. 5: Example diagram for nominal size DN 100
 * For DN 65 and DN 80 both installation positions are possible

5.3 Mounting of the integrator

Fasten the enclosed C-rail with two screws in a horizontal position at the chosen place. Attach the housing to the C-rail and lift the red snap hook using a flat slot screw driver.

Press the body onto the C-rail and release the snap hook.

For removal lift the red snap hook with a flat slot screw driver and take the housing off.



Figure 6: Back of the housing with mounted C-rail

6. Connection of the sub-units

To open the housing press the two locking caps at the two lower angles of the housing lid and turn the lid upwards.



Figure 7: Open terminal block, one of the preshaped rubber parts removed

6.1 Connection of the flow sensor

The pulse cable is connected to terminal 10 (+) and 11 (-). Polarity can be disregarded for flow sensors with Reed contacts. An extension of the connection cable is only permitted with shielded cable.

6.2 Connection of the temperature sensors

PolluTherm can be operated with temperature sensors Pt 500. The type which has to be used is marked on the front of the calculator housing. The required minimum distance from sources of

electromagnetic interference (generators, frequency converters, ...), as well as from cables carrying ≥ 230 V, is 0.3 m. Two-wire or four-wire connection is possible (to extend the length of the temperature sensor cables by max. 23 m, cable type: e. g. I-Y(St)Y 2x2x0,8, minimum core size: 0,5 mm², see also chapter. 12). Allocation as follows:

Supply pipe temperature sensor (warmer line):

Connection type	Terminals
Two-wire connection	5, 6
Four-wire connection	5, 6 and 1, 2
Screening, if any	⊥

Return pipe temperature sensor (colder line):

Connection type	Terminals
Two-wire connection	7, 8
Four-wire connection	7, 8 und 3, 4
Screening, if any	⊥

Start by removing the appropriate preshaped rubber part from the integrator housing (see figure 7). Then pull the cable through the hole in the preshaped rubber part and provide strain relief by using one of the supplied cable binders (see figure 8). Now connect the cores to the corresponding terminals and replace the preshaped rubber part (see figure 9).

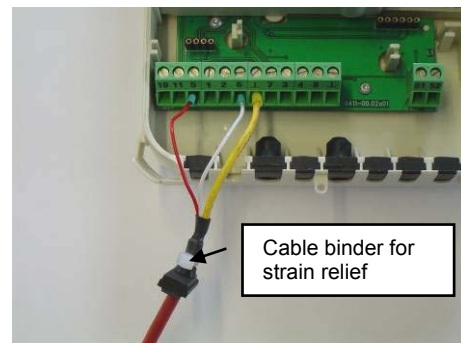

Figure 8: Example of two-wire connection with a shielded cable

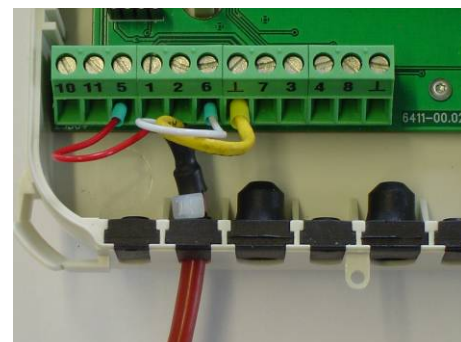

Figure 9: Cores connected, preshaped rubber part replaced

Temperature sensor types which are supplied from the factory with already attached preshaped rubber parts (see figure 10) can be placed directly into the integrator housing – it is not required to use a cable binder.

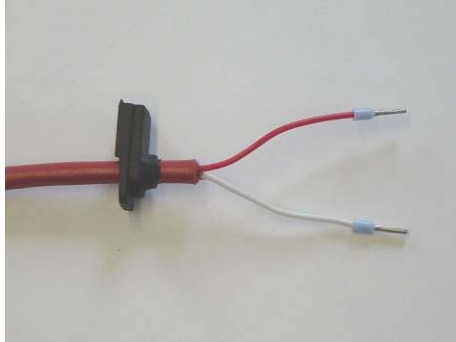

Figure 10: Cable incl. already attached preshaped rubber part

Proceed accordingly when using a four-wire connection (see figure 11 and chapter 12).

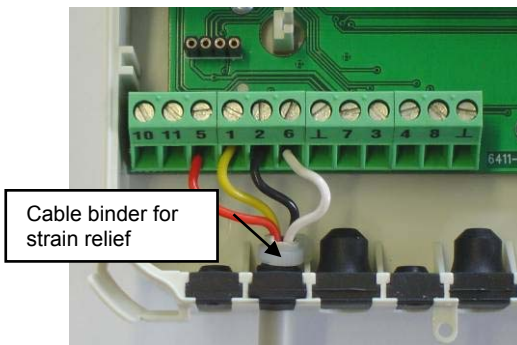

Figure 11: Example of four-wire connection with an unshielded cable

7. Exchange of the integrator module

After expiry of the certification or the operating life it is sufficient to exchange the calibrated module within the casing. For this purpose open the integrator lid and remove the fastening screw (screw driver Torx 6) above the LC display (see figure 12). Then pull the module carefully forwards.

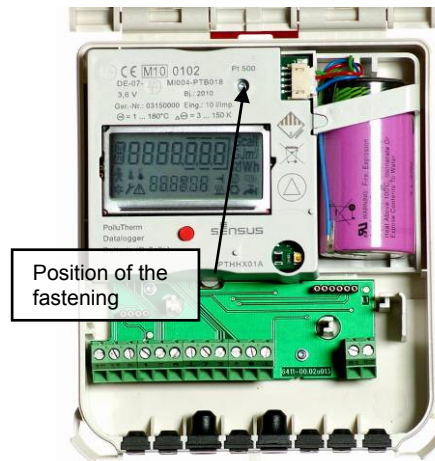

Figure 12: Removal of the module fastening screw

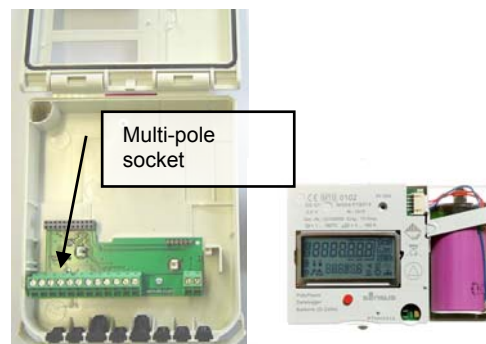

Figure 13: Module removed from integrator housing

Carefully insert the new module, slowly press it down and tighten the fastening screw.

For mains operated units which have been supplied until September 2010 the power supply must also be replaced because the supply voltage has changed from 3 to 3.6 V.

8. Display options

The different display options of PolluTherm are divided into six menus. Displays marked with (*) are masked in the standard version. Depending on the version of the meter they can be displayed. If necessary the mask can be changed with the service software MiniCom, version 3.6.0.65 or higher, using the optical data interface of the meter. In the basic state the display switches on for one second in intervals of 4 seconds and shows the accumulated heat energy. By a push on the red key the first display item in the user menu (accumulated heat energy) is activated. The other five menus can be obtained by pushing the red key for 8 seconds. The selection menu L1 to L6 appears:

L1	User menu
L2 ↓	Target day menu
L3 Ⓜ	Archive menu
L4 ✱	Service menu
L5 Ctrl	Control menu for tariff purposes
L6 ↵	Parameter menu

Figure 14: Change of display menus

The menus can be selected in sequence by short pushes on the red key. As soon as the desired menu appears, hold the red key for 2 seconds in order to obtain this menu. Each one of the single display items in the menus will be activated one after another by a short push on the key. If there is no key operation within approx. 4 minutes, the display returns automatically to the basic state. In all levels incoming volume pulses are indicated by a flashing vane symbol (lower left corner of the display).

8.1 User menu (example)

Err 40 10 ▲	Error message (in case of error only)
20533 MWh	Accumulated heat and cooling energy resp.
14823 MWh 311209 ↓	Target day consumption incl. corresponding date
895473 m ³	Accumulated volume
00000000 Gcal t 00000000 GJm ³ 00000000 kWh 00000000 MWh 00000000 m ³ 00000000 s	Segment test

0000 L1 IMP	Pulse value of the flow sensor
9853 MWh Ⓜ	Tariff consumption 1 * (if activated)
5469 MWh Ⓜ	Tariff consumption cold * (if activated)
5230763 m ³ Ⓜ	Consumption first external meter *
67362 m ³ Ⓜ	Consumption second external meter *
1468 m ³ /h	Current flow rate
53853 kW	Current power
PC 698 Ⓜ	Temperature in warmer line
PC 380 Ⓜ	Temperature in colder line
Δ 31827 Ⓜ	Temperature difference
03840275 CL IEnt	Customer's reference number
2 PrAdr	Primary M-Bus address (factory setting: 0) *
03840275 SECAdr	Secondary M-Bus address (factory setting: Serial number) *

8.2 Target day menu (example)

All display items are marked with an arrow symbol. Display of all stored values on an adjustable annual target.

	Target day value for heat and cooling energy resp.
	Target day value for volume
	Target day value for tariff 1 (if activated) *
	Target day value for tariff cold (if activated) *
	Target day value first external meter *
	Target day value second external meter *
	Return to selection menu (push for 2 seconds)

	Tariff consumption cold (if activated) *
	Consumption first external meter *
	Consumption second external meter *
	Maximum flow rate in selected month incl. date (average)
	Maximum flow rate in selected month incl. time (average)
	Maximum power in selected month incl. date (average)
	Maximum power in selected month with time (average)
	Failure hours
	Hours of power failure (only relevant for mains-operated instruments) *
	Return to month selection (push for 2 seconds)

8.3 Archive menu (example)

All display items are marked with a calendar sheet symbol. Starting from the current date, the values on the turn of the past 16 months are displayed (six-figure date, format: dd.mm.yy, below the main display).

In addition the values for the current month can be recalled. For this purpose "today" has to be selected for the month.

	Selection of the required month by short keystroke, then push key for 2 seconds
	Heat and cooling energy resp.
	Volume
	Tariff consumption 1 (if activated) *

In order to exit the archive menu double click when the display shows a month selection or wait for five minutes.

8.4. Service menu (example)

Each display item is marked with a man symbol. The service menu shows maximum values and meter settings.

	Absolute maximum flow rate incl. date (average)
	Absolute maximum flow rate incl. time (average)

Heat / Cooling meter integrator PolluTherm

Installation and operation instructions



M * 787032 kW 1709.10	Absolute maximum power incl. date (average)
M * 787032 kW 08h59	Absolute maximum power incl. time (average)
M * 89.3 1709.10	Absolute maximum temperature in warmer line incl. date
M * 52.8 1709.10	Absolute maximum temperature in colder line incl. date
03-10-10 * DATE	Current date
11h23 * TIME	Current time *
31-12-10 * DATE	Next target day
d * 293	Operation days
* 3600 BATT	Battery voltage (calculated) *
h * 0	Accumulated failure hours
HAC * 0	Hours of power failure (only relevant for mains-operated instruments) *
* 123 PrAdr	Primary M-Bus address (factory setting: 0)
* 03840275 SECAAdr	Secondary M-Bus address (factory setting: serial number)
* 0nE COMPA	Data communication mode (length and structure of M-Bus protocol)
* 30	Firmware version

erc 65AE *	Checksum
37056833 Wh *	High-resolution energy display
95413300 L *	High-resolution volume
* rEturn	Return to selection menu (push for 2 seconds)

8.5 Control menu for tariff purposes (example)

Each display item is marked with the letters „Ctrl“. The settings for the tariff functions can be controlled here.

M in 15 Ctrl	Preset averaging interval for flow rate and power
5.069 kW Ctrl	Power in current averaging interval
1432 m ³ /h Ctrl	Flow rate in current averaging interval
60000 kW [⊕] Ctrl	Set tariff 1 (if activated) *
°C 25.0 Ctrl ⊙	Switchover point for supply temperature cool metering (if activated) *
Δ 0.750 Ctrl ⊙	Switchover point for negative temperature difference cool metering (if activated) *
CF 1000 Ctrl	Correction factor for water-antifreeze mixtures (if activated)
* rEturn Ctrl	Return to selection menu (push for 2 seconds)









8.6 Parameter menu (example)

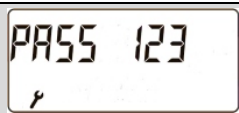

Each display item is marked with the tool symbol. This menu is protected by password. The password corresponds to the last three digits of the eight-digit serial number on the meter housing.

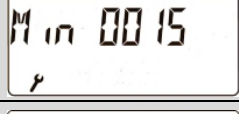
At the beginning "000" appears. Push the key for approx. 2 seconds; the zero on the left side starts flashing. By continuously pushing the key the value of the flashing digit can be changed. As soon as the desired value is obtained release the key. A short key stroke confirms the set value and switches to the next position. Proceed as mentioned in the previous step. After setting the last digit the level is activated.

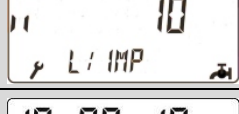
The desired positions can now be selected by short keystroke; adjusting the values is similar to the password entry procedure.

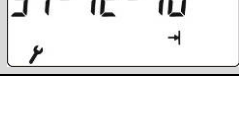
Default values are read out with the setting "OnE COMPA". The setting "OnE, OnE Plus, ALL" additionally activates the read out of further information.

	Password scan
	Setting primary M-Bus address
	Setting secondary M-Bus address
	Setting customer's reference number
	Setting averaging interval for flow rate and power
	Setting data transmission mode (One, All, One Plus, One Compa)
	Input pulse value first external meter (0,25 to 10.000 L/pulse) *
	Input pulse value second external meter (0,25 to 10.000 L/pulse.) *
	Set date
	Set time *
	Set target day

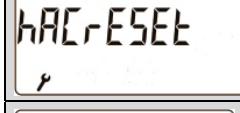
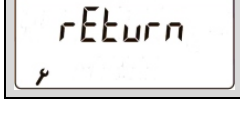
	Reset absolute maxima *
	Reset failure hours *
	Reset hours of power failure *
	Return to selection menu (push for 2 seconds)

9. Functional test, sealing

After opening the shut-off valves test the installed units for leaks. For control purposes the current values of flow rate, power, supply and return flow temperature can be recalled (see chapter 8.1). In order to protect the meter from manipulation it has to be sealed in the following places using the enclosed selflock seals:

- Screw connection of flow sensors
- Installation points of temperature sensors
- Integrator lid (pull the sealing wire through the lug at the bottom edge)

10. Potential error situations

PolluTherm is equipped with an automatic self-checking function. In case of error a four-figure error code appears on the display in the format „Err XYZ0“ which can be decoded as follows:

- X:** Control of the temperature sensor
- Y:** Control of the integrator
- Z:** Error statistics

Extract:

Code	Meaning
Err 1010	Temperature sensors interchanged or return flow temperature exceeds supply flow temperature
Err 2010 or 3010	One or both temperature sensors is/are short-circuited
Err 4010 or 5010	Cable break of return flow temperature sensors
Err 6010 or 7010	Supply flow temperature sensor short-circuited and cable break in return flow temperature sensor
Err 8010 or 9010	Cable break of supply flow temperature sensors
Err A010 or B010	Return flow temperature sensors short-circuited and cable break in supply flow temperature sensors
Err C010 or D010	Cable break of supply and return flow temperature sensors

In most cases the error situation „Err 1010“ is caused by temporary system conditions, where the temperature in the warmer line drops by at least 3K below the temperature in the colder line.

In case of all other error codes please contact our Technical Service Centre.

Due to the incorporated back up battery the **mains-operated** PolluTherm can maintain the measuring and counting operation for up to 90 days in case of an interruption of the power supply (power failure)

Communication (M-Bus, MiniBus) with the meter is not possible. During this period the following message appears on the LC display:



After 90 days the measuring and counting function will be interrupted in case of power failure. In this case the backup battery secures the main memory and carries on date and time.

11. Data interface and options

PolluTherm has the following serial interfaces and can be equipped or retrofitted with following options:

11.1 Optical interface

All meters are equipped with a standard optical data interface. Via optical data coupler (e. g. order number 04410230 for RS 232 connection or order number 184023 for USB connection) settings can be changed with the programming software MiniCom; the meter can be read out via the read out system SensusREAD. After any short keystroke the data interface is activated for an hour. Any intervening data communication causes this period to begin anew so that e.g. a quarter-hourly or hourly logger reading can be performed over a longer period of time.

11.2 Mini-Bus interface

The Mini-Bus interface is standard equipment and is available at terminal 51 (signal) and 52 (ground). This option is suitable for the connection of an inductive readout point (MiniPad) or other reading and transmitting instruments (e.g. radio transponders). The total length of the two-wire cable between the meter and the readout point must not exceed 50 m. The communication

protocol corresponds to the M-Bus protocol and the meter can be read out via MiniReader or SensusREAD.

11.3 M-Bus-plug-in unit acc. to EN 13757-3

(Order number: 68504020)

This plug-in unit allows readout of the meter via its primary or secondary address with an M-Bus level converter (300 and 2400 baud, automatic recognition). Both addresses can be set in the parameter menu (see chapter 5.6) or with the service software MiniCom (general information: The factory presetting of the secondary address and the customer number corresponds to the serial number shown on the meter housing). The primary address can be set between 0 and 250 and is preset in the factory to 0.

Battery devices have an M-Bus credit. Depending on the number of meters the daily reading is therefore limited. The M-Bus credit will be switched off when the device is retrofitted from battery to mains operation; the communication is then unlimited (see chapter 11.12 "Retrofitting from battery to power supply unit").

11.4 Remote reading plug-in unit

Remote reading plug-in unit FZS/N (order number: 68503920) for output of heat quantity and volume pulses (for mains-operated devices only)

Remote reading plug-in unit FZS/B (order number: 68503922) for output of heat quantity pulses (for battery-operated devices)

Closing time:	ca. 125 ms
Max. voltage:	28 V DC or AC
Max. power:	0,1 A
Bounce- and potential free	

11.5 M-Bus plug-in unit with two contact inputs

Order number: 68504686

In addition to the plug-in units specified in chapter 8.3 there is the possibility to connect two external consumption meters (cold water, warm water, electricity, gas, others) with passive remote reading contact (reed switch or open collector).

Specifications of the contact inputs:

Required closing time:	> 62,5 ms
Input frequency:	≤ 3 Hz
Terminal voltage:	3 V

Preprogrammed factory setting of both contact inputs:

- *Input 1*: cold water meter, pulse value 10 litres, initial meter reading 0,00 m³
- *Input 2*: warm water meter, pulse value 10 litres, initial meter reading: 0,00 m³

The activation of the inputs has to be done via the service software MiniCom, menu item “set pulse input parameters“.

The meter IDs of the pulse meters have to be set there as well as the primary M-Bus addresses if necessary; check “counter 1 (2) visible on the M-Bus”. Starting meter reading and pulse value can also be adapted. Afterwards the pulse meters are available as autonomous M-Bus meters on the M-Bus. The consumption of the pulse meters will not be transferred in the M-Bus protocol of the heat meter.

11.6 USB plug-in unit (for M-Bus slot)

Order number: 68504688

With this plug-in unit the integrator can be connected with a PC / Notebook or Handheld Computer with USB input. If an M-Bus plug-in is installed it has to be removed beforehand. To connect you need a software driver that is supplied on a disk (incl. driver installation description).

11.7 USB plug-in unit with 2 inputs for external consumption meters (for M-Bus slot)

Order number: 68504902

Two meters with pulse output can be additionally connected to this USB plug-in unit (see description 11.5).

11.8 LONWORKS®-FTT10A (for M-Bus slot)

This plug-in module (order number: 68504857) is used to implement the meter via LONTALK[®] protocol into a building automation system. A driver software is included on a Mini CD. For detailed information please refer to datasheet LH 6130 INT.

11.9. Inserting the plug-in unit into the heat meter

Valid modules may only be mounted in the designated slots.

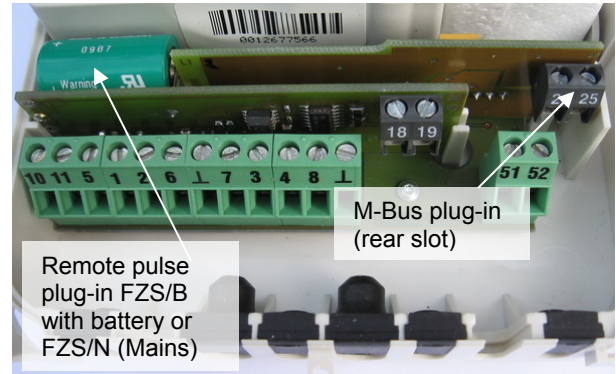

Figure 14: mounting of the plug-in units

Insert the plug-in units in the white plastic slide on the left and right side.

The contact pins may not be bent; they easily slide into the appropriate contact sockets.

Lead the contact cable through the hole in the preshaped rubber part and tie the strain relief with the supplied cable binder. Connect the cores with the appropriate terminals and insert the rubber part again.

11.10 Combined heating/cooling meter (ordering option)

Description:

PolluTherm H or PolluTherm X H

At an automatic switch-over point this PolluTherm version switches over between metering heating and cooling energy. The switch-over point to cool metering is preset in the factory to:

supply flow temperature ≤ 25 °C and
negative temperature difference $\geq -0,15$ K

Conditions to switch back to heat metering:

supply flow temperature > 25 °C and
positive temperature difference $\geq 0,15$ K

If required this switch-over point can be changed on site with the service software MiniCom, version 3.6.0.65 or higher.

11.11 Optional integrated data logger (ordering option)

When the option is built in the housing lid is additionally labeled with „data logger“.

The integrated data logger stores consumption values and instantaneous values (power, flow rate, temperatures) during a selectable time interval (3 to 1440 minutes). The logger data can be read out via the optical interface M-Bus or

Heat / Cooling meter integrator PolluTherm Installation and operation instructions



Mini-Bus with the service software MiniCom version 3.6.0.65 or higher. The time interval (factory setting: 60 minutes) can also be changed with MiniCom.

For PC connection use either an optical data coupler (see chapter 11.1.) or a USB plug-in unit (order number: 68504688).

11.12 Retrofitting from battery unit to power supply unit

Before retrofitting please note the following instructions and perform in chronological order:

- Before you remove the supply battery from the integrator the integrated module has to be removed from the integrator. Unscrew only the screw on the right side under the KK1 seal (user seal) of the plastic cover. Pull the integrated module forward from the connection. The seals in the middle and on the left side may not be removed (loss of calibration)!
- Insert the backup battery AA 3,6V (68504900) on the backside of the integrator module. The battery is needed for the backup date and for the short-term emergency use in case of power failure.
- Remove the main battery (D) and plug in the mains module.

For a detailed description please refer to installation manual MH 1122.

12. Information on the extension of temperature sensor cables

The temperature sensors for PolluTherm are available with platinum resistor elements in:

Pt 500 (500 Ohm at 0 °C) Standard

For each integrator two temperature sensors are required. Therefore such sensors are paired regarding on their resistance and supplied as calibrated instruments. This ensures that incorrect temperature difference in the heating and/or cooling system will not be registered because of different characteristic curves of temperature sensors and cable resistance.

In some systems it is often necessary to extend one or both temperature sensors. The length of the temperature sensor cables can be extended by max. 23 m. In order to compensate for the additional cable resistance so-called four-wire technology is applied. Use a four-wire cable (e.g. I-Y(St)Y 2x2x0.8, **minimum cable size: 0.5 mm²**).

It is possible

- to extend only one cable
- to extend both cables; they do not necessarily need to have the same length

The extension of the temperature sensors may be done with the junction box that is offered from Sensus (see figure 15, order number: 88599001, installation manual MH 6105).

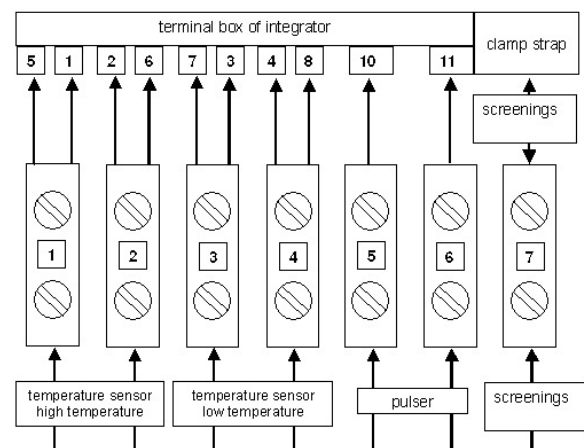

Figure 15: Connection diagram

By connecting the two additional wires for each temperature sensor at the terminal block of the integrator, i.e. for the higher temperature 1 and 2 and for the lower 3 and 4, the electric resistance of the extension cable or cables does/do not influence the measurement and the reading of the temperatures.

Material number: 28505033

Edition: 003-1010

Subject to change without prior notice
Sensus GmbH Ludwigshafen
Industriestraße 16
D-67063 Ludwigshafen

Phone: + 49 (0) 621 6904-1113

Fax: + 49 (0) 621 6904-1409

E-Mail: info.de@sensus.com



Annex 1: Declaration of conformity acc. directive 2004/22EC (MID)



Date: 15.10.2009

Declaration of Conformity

no. CE/PolluTherm/0807

Herewith we,

**Sensus GmbH Ludwigshafen
Industriestr.16
67063 Ludwigshafen**

declare under our sole responsibility, that the calculator **PolluTherm**, to which this declaration relates, is in conformity with the legal regulation of the Directive 2004/22/EC of the European Parliament and the Council of the 31st of March 2004 on measuring instruments, including

Annex I, Essential requirements
Annex MI-004, heat meter

applied normative, harmonized documents

- OIML-R 75, Edition 2002
- CEN EN 1434, Edition 2007

other standards:

- WELMEC-guideline 7.2 (2005)

EN 60751, edition 1996	EN 61000-4-2, edition 2001
EN 13757-2, edition 2005	EN 61000-4-3, edition 2005
EN 13757-3, edition 2005	EN 61000-4-4, edition 2005
EN 55022 B, edition 2003	EN 61000-4-5, edition 2001
EN 61000-6-1, edition 2002	EN 61000-4-6, edition 2001
EN 61000-6-3, edition 2005	EN 61000-4-8, edition 2001
DIN EN 60529, edition 2003	EN 61000-4-11, edition 2005
DIN EN 60 870, edition 2006	Directive 2006/95/EG

This declaration is made on behalf of the manufacturer by the Technical Director.

Sensus GmbH Ludwigshafen

Sensus GmbH Ludwigshafen

Bankverbindung: Deutsche Bank Ludwigshafen
Konto: 024 913 600 (BLZ 545 700 94)
www.sensus.com

Telefon: + 49 (0) 621 / 6904 – 0
Telefax: + 49 (0) 621 / 6904 – 1490
Amtsgericht: Ludwigshafen HRB 5153
Geschäftsführung:
Aufsichtsratsvorsitzender:

Industriestraße 16
D-67063 Ludwigshafen
Ust-Id-Nr.: DE 160261426
Peter Karst, Harald Tiemann, Colin Walsby
Jose Hernandez